

# BANDSAW PARTS

Please call for parts needed that are not illustrated. Most parts readily available including: wheel, shaft and bearing assemblies, cleaner assemblies etc. as well as individual component parts.

## REPLACEMENT PARTS FOR BIRO SAWS

FOR USE WITH  
**BIRO**  
SAWS

### MAINTENANCE/REPAIR KIT

Models 11, 22, 33, 1433, 1433FH, 3334, 3334FH

**BRK2** ..... Biro Repair Kit

Kit Includes:

- |                                     |                                |
|-------------------------------------|--------------------------------|
| 1 ..... Upper Guide & Carbide Block | 2 ..... Wheel Cleaners         |
| 1 ..... Lower Saw Guide             | 2 ..... Bumpers                |
| 3 ..... Filler Blocks               | 2 ..... Blade Cleaner (Steel)  |
| 2 ..... Filler & Guide Studs        | 2 ..... Blade Cleaner (Nyleen) |

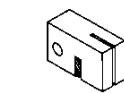

**B045602**  
Upper Guide & Carbide Block



**B002119V**  
Lower Saw Guide

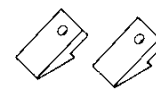

**B005179**  
Wheel Cleaner (Fiber)

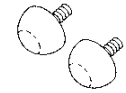

**B008311**  
Bumper

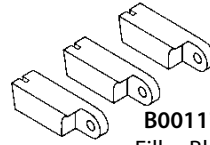

**B001177**  
Filler Block (Nylon)

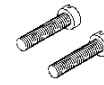

**B017268**  
Filler & Guide Stud

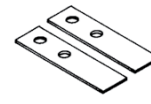

**B004131S**  
Blade Cleaner (Steel)

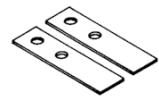

**B004131N**  
Blade Cleaner (Nyleen)

### REPAIR KIT FOR BIRO SAWS

All Models

**BRKFW** ..... Biro Repair Kit

Kit Includes:

- |                        |                                |
|------------------------|--------------------------------|
| 3 ..... Filler Block   | 2 ... Blade Cleaners (Nyleen)  |
| 4 ..... Wheel Cleaners | 2 ..... Blade Cleaners (Steel) |

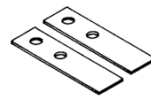

**B004131S**  
Blade Cleaner (Steel)

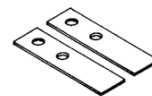

**B004131N**  
Blade Cleaner (Nyleen)

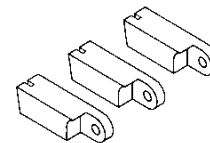

**B001177**  
Filler Block (Nylon)

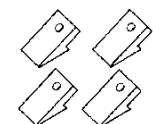

**B005179**  
Wheel Cleaner (Fiber)

Order complete Maintenance/Repair kit or individual parts as needed.

## BIRO SAW PARTS

FOR USE WITH  
**BIRO**  
SAWS



**B045602**  
Upper Guide & Carbide Block

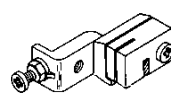

**B055A601**  
Upper Guide & Bracket Assembly

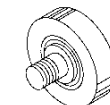

**B020159**  
Table Bearing (1 7/16" dia.)



**B005179**  
Wheel Cleaner



**B141**  
Tension Spring Gauge



**B139**  
Tension Spring Pin



**B140**  
Tension Spring

**B028A415**  
Stationary Bar Assembly

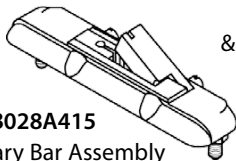

**B032A361/33**  
Lower Wheel Shaft & Bearing Assembly (Straight Shaft only)

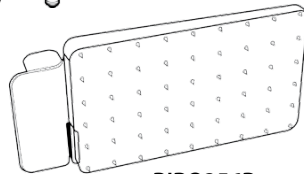
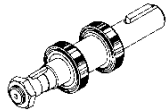

**BIRO256P**  
Pusher Plate

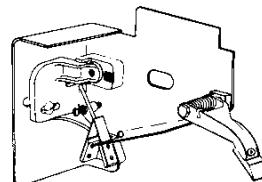

**B018AC**  
Cleaning Unit Assembly Complete with Carbide Block

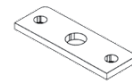

**B024A130/N**  
Blade Scraper Bracket with Cleaners (Nyleen)

**B075**  
Tension Spring Plate

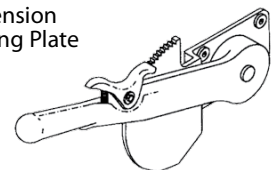

**B136A**  
Ratchet Arm Assembly Complete

**B033A247**  
Upper Wheel Shaft & Bearing Assembly

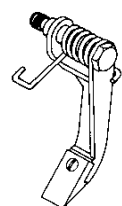
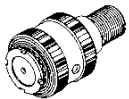

**B009A295**  
Cleaning Arm Assembly

Item Number	Description
<b>B045602</b> .....	Upper Guide & Carbide Block
<b>B055A601</b> .....	Upper Guide & Bracket Assy
<b>B005179</b> .....	Wheel Cleaner
<b>B141</b> .....	Tension Spring Gauge
<b>B140</b> .....	Tension Spring
<b>B139</b> .....	Tension Spring Pin
<b>B075</b> .....	Tension Spring Plate
<b>B028A415</b> .....	Stationary Bar Assy
<b>B020159</b> .....	Table Bearing
<b>B024A130/N</b> ...	Blade Scraper Bracket
<b>B136A</b> .....	Ratchet Arm Assy
<b>B033A247</b> .....	Upper Wheel Shaft & Bearing Assy
<b>B032A361/33</b> ..	Lower Wheel Shaft & Bearing Assy
<b>BIRO256P</b> .....	Pusher Plate
<b>B018AC</b> .....	Cleaning Unit Assembly
<b>B009A295</b> .....	Cleaning Arm Assembly

#### FITS MODELS

	11	22	33	34	44	55	1433	1433FH	3334	3334FH	4436
<b>B045602</b> .....	X	X	X	X	X	X	X	-	X	-	X
<b>B055A601</b> .....	X	X	X	X	X	X	X	-	X	-	X
<b>B005179</b> .....	X	X	X	X	X	X	X	X	X	X	X
<b>B141</b> .....	X	X	X	X	-	-	X	-	X	-	-
<b>B140</b> .....	X	X	X	X	-	-	X	-	X	-	-
<b>B139</b> .....	X	X	X	X	-	-	X	-	X	-	-
<b>B075</b> .....	-	-	-	-	-	-	X	-	X	-	-
<b>B028A415</b> .....	X	X	X	X	X	-	-	-	X	X	X
<b>B020159</b> .....	-	-	-	X	X	X	X	X	X	-	-
<b>B024A130/N</b> ...	X	X	X	X	X	-	-	-	X	X	X
<b>B136A</b> .....	X	X	X	X	-	-	X	-	X	-	-
<b>B033A247</b> .....	X	X	X	X	-	-	X	X	X	X	-
<b>B032A361/33</b> ..	-	-	X	-	-	-	-	-	X	X	-
<b>BIRO256P</b> .....	X	X	X	X	X	X	X	X	X	X	X
<b>B018AC</b> .....	-	-	-	-	-	-	-	-	X	X	-
<b>B009A295</b> .....	X	X	X	X	X	-	X	X	X	X	X

Please call for parts needed that are not illustrated. Most parts readily available including: wheel, shaft and bearing assemblies, cleaner assemblies etc. as well as individual component parts.

## REPLACEMENT PARTS FOR BUTCHER BOY SAWS

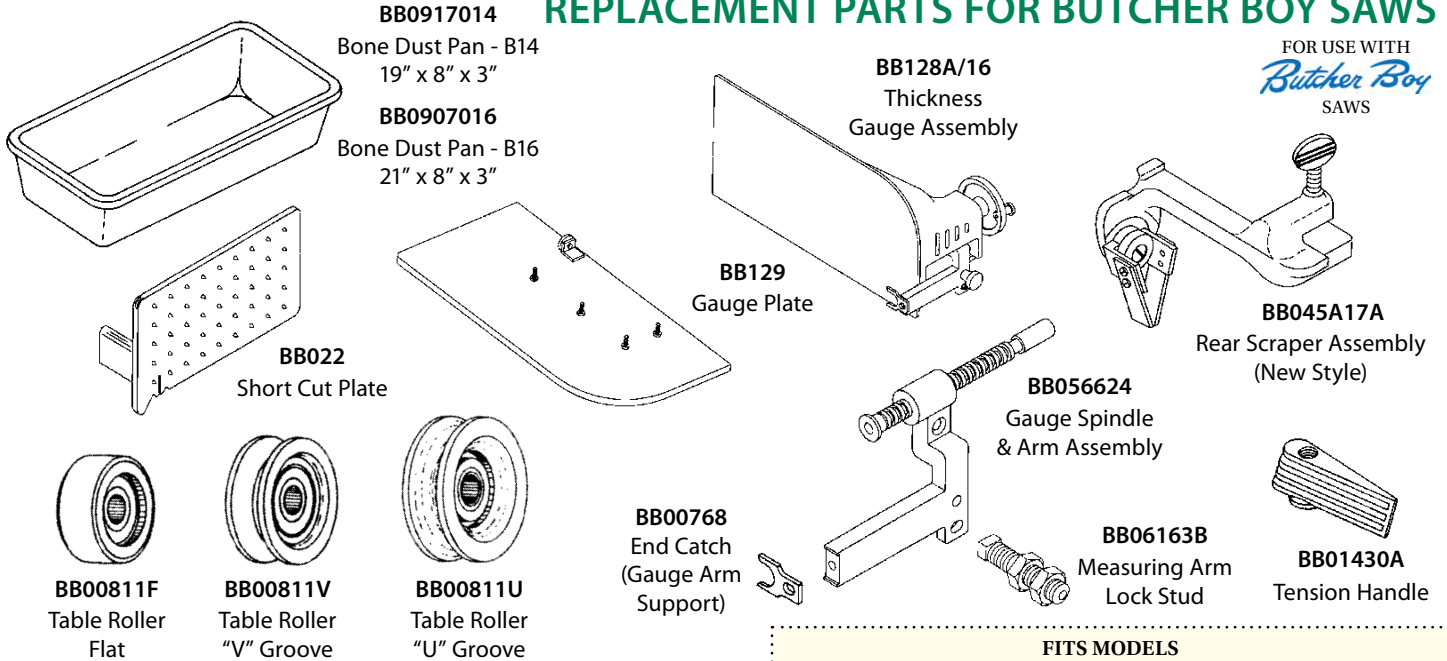

FOR USE WITH  
*Butcher Boy*  
SAWS

FITS MODELS									
B12	B14	B16	1435	1640	14	COBRA 16	SA16	SA20	
X	X	OLD	X	-	X	-	-	-	
-	-	X	-	X	-	X	-	-	
-	X	-	X	-	X	-	-	-	
X	X	X	X	X	X	X	-	-	
X	X	X	X	X	X	X	-	-	
X	X	X	X	X	X	X	-	-	
X	X	X	X	X	X	X	-	-	
X	X	X	X	X	X	X	-	-	
X	X	X	X	X	X	X	-	-	
X	X	X	X	X	X	X	-	-	
X	X	X	X	X	X	X	-	-	

Item Number	Description
<b>BB01430A</b>	Tension Handle
<b>BB0907016</b>	Bone Dust Pan - B16, 21" x 8¼" x 3½"
<b>BB0917014</b>	Bone Dust Pan - B14, 19" x 8½" x 3½"
<b>BB045A17A</b>	Rear Scraper Assembly (New Style)
<b>BB022</b>	Short Cut Plate
<b>BB128A/16</b>	Thickness Gauge Assembly
<b>BB129</b>	Gauge Plate
<b>BB00811F</b>	Table Roller Flat
<b>BB00811V</b>	Table Roller "V" Groove
<b>BB00811U</b>	Table Roller "U" Groove
<b>BB056624</b>	Gauge Spindle & Arm Assembly
<b>BB00768</b>	End Catch (Gauge Arm Support)
<b>BB06163B</b>	Measuring Arm Lock Stud

## BUTCHER BOY REPAIR KIT

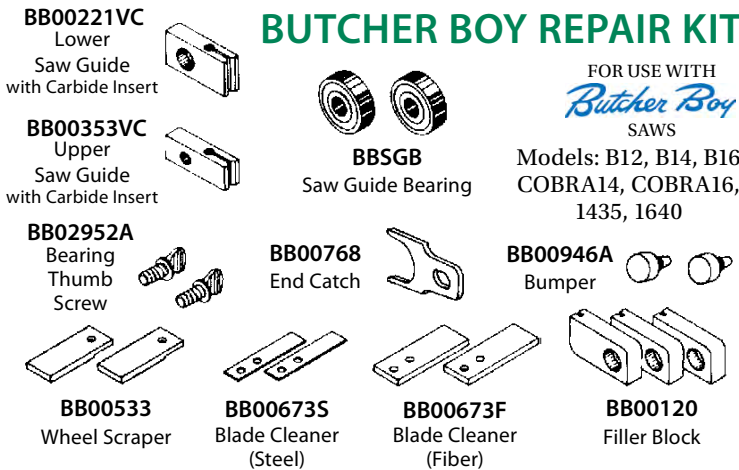

## HARDWARE KIT



**BBRK1** ..... Butcher Boy Repair Kit

Kit Includes:

- |                             |                               |
|-----------------------------|-------------------------------|
| 2 ..... Saw Guide Bearing   | 1 ..... End Catch             |
| 1 ..... Lower Saw Guide     | 2 ..... Blade Cleaner (Steel) |
| 1 ..... Upper Saw Guide     | 2 ..... Bumper                |
| 2 ..... Bearing Thumb Screw | 2 ..... Wheel Scraper         |
| 3 ..... Filler Block        | 2 ..... Blade Cleaner (Fiber) |

We Gladly Welcome



# BANDSAW PARTS

## REPLACEMENT PARTS FOR BUTCHER BOY SAWS

FOR USE WITH  
*Butcher Boy*  
SAWS

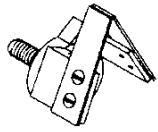

**BB041A66F**  
Blade Scraper Holder  
Assembly (Fiber)

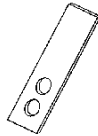

**BB00673F**  
Blade Cleaner (Fiber)  
**BB00673S**  
Blade Cleaner (Steel)

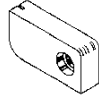

**BB00120**  
Filler Block (Nylon)  
**BB118**  
Filler Block (Fiber)

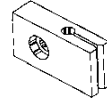

**BB00221V**  
Lower Saw Guide  
with "V" Front

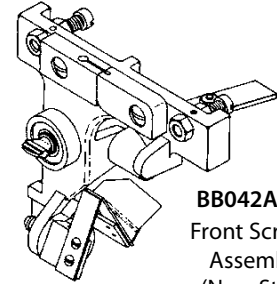

**BB042A15A**  
Front Scraper  
Assembly  
(New Style)



**BB001A20A/S**  
Filler Stud  
(Short) 1"

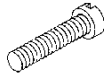

**BB001A20A/L**  
Scraper Mount Stud  
(Long) 1"

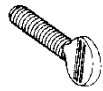

**BB02556C**  
Table Thumb Screw



**BB00946A**  
Bumper

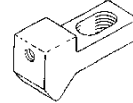

**BB07256F**  
Lever Adjusting Lock

**BB012456**  
Table Stop  
Assembly

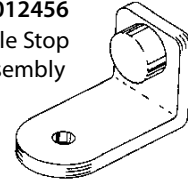

### UPPER WHEEL Upper wheel assembly with hangers are complete with shaft, bearings, seals, gaskets, spacer, hub cap & retainer.

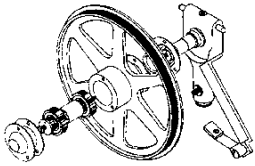

**BB103AH16**  
Wheel Assembly  
with Hanger (New Style)

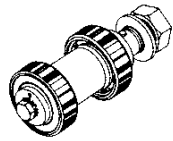

**BB019A7**  
Upper Shaft & Bearing Assembly  
with Metal Shields



**BBUMB**  
Upper Main Bearing  
with 1 Metal Shield  
(Upper wheel requires 2 bearings)



**BB05241D**  
Upper & Lower  
Shaft Seal

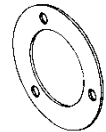

**BB05141C**  
Shaft Gasket

### LOWER WHEEL

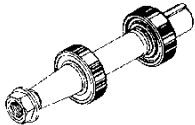

**BB020A23**  
Lower Shaft Assembly  
with Metal Shields



**BBLMB**  
Lower Main Bearing  
with 1 Metal Shield  
(Lower wheel requires 2 bearings)

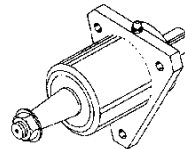

**BB123A**  
Lower Main Bearing Housing Assembly  
Includes bearings, shaft, grease, retaining  
rings, seal, nut, washer & square key



**BB0811610**  
Lower Wheel Only

Item Number

Description

<b>BB00120</b> .....	Filler Block (Nylon)
<b>BB118</b> .....	Filler Block (Fiber)
<b>BB00221V</b> .....	Lower Saw Guide with "V" Front
<b>BB041A66F</b> .....	Blade Scraper Holder Assembly (Fiber)
<b>BB001A20A/S</b> .....	Filler Stud (Short) ¾"
<b>BB001A20A/L</b> .....	Scraper Mount Stud (Long) 1"
<b>BB00673F</b> .....	Blade Cleaner (Fiber)
<b>BB00673S</b> .....	Blade Cleaner (Steel)
<b>BB042A15A</b> .....	Front Scraper Assembly (New Style)
<b>BB00946A</b> .....	Bumper
<b>BB07256F</b> .....	Lever Adjusting Lock
<b>BB02556C</b> .....	Table Thumb Screw
<b>BB012456</b> .....	Table Stop Assembly
<b>BB103AH16</b> .....	Wheel Assembly with Hanger (New Style)
<b>BB019A7</b> .....	Upper Shaft & Bearing Assembly with Metal Shields
<b>BB020A23</b> .....	Lower Shaft & Bearing Assembly with Metal Shields
<b>BB123A</b> .....	Lower Main Bearing Housing Assembly
<b>BB0811610</b> .....	Lower Wheel only
<b>BBUMB</b> .....	Upper Main Bearing with 1 Metal Shield
<b>BB05241D</b> .....	Upper & Lower Shaft Seal
<b>BB05141C</b> .....	Shaft Gasket
<b>BBLMB</b> .....	Lower Main Bearing with 1 Metal Shield

#### FITS MODELS

	B12	B14	B16	1435	1640	COBRA		SA20
						14	16	
	X	X	X	X	X	X	X	-
	X	X	X	X	X	X	X	-
	X	X	X	X	X	X	X	X
	X	X	X	X	X	X	X	X
	X	X	X	X	X	X	X	-
	X	X	X	X	X	X	X	-
	X	X	X	X	X	X	X	X
	X	X	X	X	X	X	X	X
	X	X	X	X	X	X	X	X
	X	X	X	X	X	X	X	X
	X	X	X	X	X	X	X	X
	X	X	X	X	X	X	X	X
	X	X	X	X	X	X	X	X
	X	X	X	X	X	X	X	X
	X	X	X	X	X	X	X	X



26

Many parts are interchangeable. Please check reference charts to make sure parts are compatible with your model of saw.

## REPLACEMENT PARTS FOR BUTCHER BOY SAWS

FOR USE WITH  
*Butcher Boy*  
SAWS

**BB102A**  
Upper Wheel Hanger -  
New Style (Complete with  
Tension Gauge Indicator,  
Spring & Cleaner Arm  
Assembly)

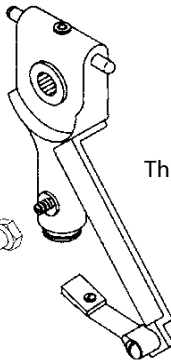

**BB112**  
Threaded Sleeve



**BB110**  
Tension Gauge  
Indicator

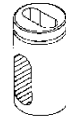

**BB0043F**  
Door Latch (New Style)

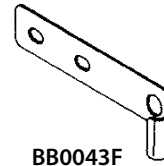

Note:  
"NEW" B16  
- Tension  
Handle  
located below  
Upper Wheel

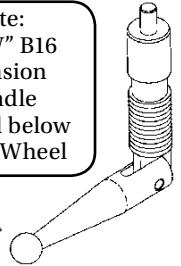

**BB111**  
Wheel Adjusting  
Screw & Nut



**BB00533**  
Wheel Scraper  
(Fiber)



**BB03959**  
Wheel Scraper Spring

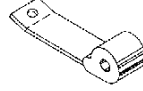

**BB0973D**  
Door Pull Guide Knob

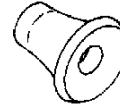

**BB101A**  
Tension Adjusting Screw  
& Handle Assembly  
New Style B16

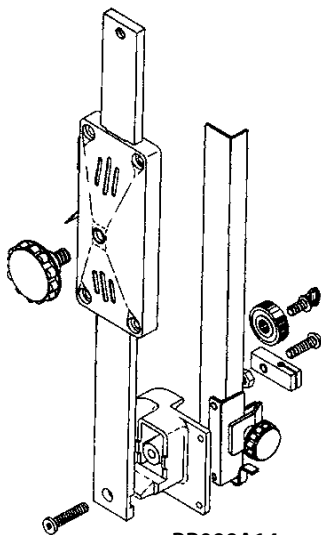

**BB099A14**  
Adjusting Bar Guide Assembly Complete  
with Guide & Roller Mount Assembly Bar  
Length: 18½"

**BB133**  
Blade Guard  
Knob



**BB02439**  
Blade Guard

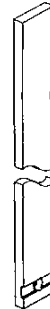

**BB04738A/16**  
Blade Support  
Adjusting Bar  
B16 Length: 18½"

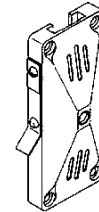

**BB09514A**  
Adjusting Bar Guide  
with Spring Lock

**BB09637A**  
Adjusting Bar  
Guide Knob



**BB04640**  
Adjusting Guide  
& Roller Mount

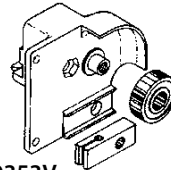

**BBSGB**  
Saw Guide  
Bearing with  
Metal Shields

**BB02952A**  
Bearing Thumb  
Screw

**BB00353V**  
Upper Saw Guide  
with "V" Front

Item Number	Description	FITS MODELS							
		B12	B14	B16	1435	1640	14 COBRA	16	SA20
<b>BB102A</b>	Upper Wheel Hanger (New Style)	-	-	NEW	-	X	-	X	-
<b>BB111</b>	Wheel Adjusting Screw & Nut	-	-	NEW	-	X	-	X	X
<b>BB112</b>	Threaded Sleeve	-	-	NEW	-	X	-	X	X
<b>BB110</b>	Tension Gauge Indicator	-	-	NEW	-	X	X	X	X
<b>BB0043F</b>	Door Latch (New Style)	X	X	X	-	-	-	-	-
<b>BB00533</b>	Wheel Scraper (Fiber)	X	X	NEW	X	X	X	X	X
<b>BB03959</b>	Wheel Scraper Spring	X	X	NEW	X	X	X	X	-
<b>BB0973D</b>	Door Pull Guide Knob	X	X	X	-	-	-	-	-
<b>BB101A</b>	Tension Adjusting Screw & Handle Assembly	-	-	NEW	-	X	-	X	-
<b>BB099A14</b>	Adjusting Bar Guide Assembly	X	X	X	-	-	-	X	-
<b>BB04738A/16</b>	Blade Support Adjusting Bar	-	-	X	-	-	-	-	-
<b>BB133</b>	Blade Guard Knob	X	X	X	X	X	X	X	X
<b>BB02439</b>	Blade Guard	X	X	X	-	-	-	-	-
<b>BB09514A</b>	Adjusting Bar Guide with Spring Lock	X	X	X	-	-	-	-	X
<b>BB09637A</b>	Adjusting Bar Guide Knob	X	X	X	-	-	-	-	X
<b>BB04640</b>	Adjusting Guide & Roller Mount	X	X	X	-	-	-	-	X
<b>BBSGB</b>	Saw Guide Bearing with Metal Shields	X	X	X	-	-	-	-	-
<b>BB00353V</b>	Upper Saw Guide with "V" Front	X	X	X	-	-	-	-	-
<b>BB02952A</b>	Bearing Thumb Screw	X	X	X	-	-	-	-	-

# BANDSAW PARTS

Please call for parts needed that are not illustrated. Most parts readily available including: wheel, shaft and bearing assemblies, cleaner assemblies etc. as well as individual component parts.

## REPAIR KIT FOR HOBART SAWS



Models 5212, 5214, 5216, 5514

**HRK1**..... Hobart Repair Kit  
Kit Includes:

- 2 ..... Back-Up Plug
- 2 ..... Back-Up Spring
- 2 ..... Carbide Back-Up Guide
- 1 ..... Upper Saw Guide
- 1 ..... Lower Saw Guide
- 2 ..... Lower Guide Studs
- 2 ..... Blade Cleaner & Wheel Assy
- 3 ..... Filler Block (Blind Hole)
- 2 ..... Wheel Cleaner Modified
- 2 ..... Fiber Blade Scraper Assy

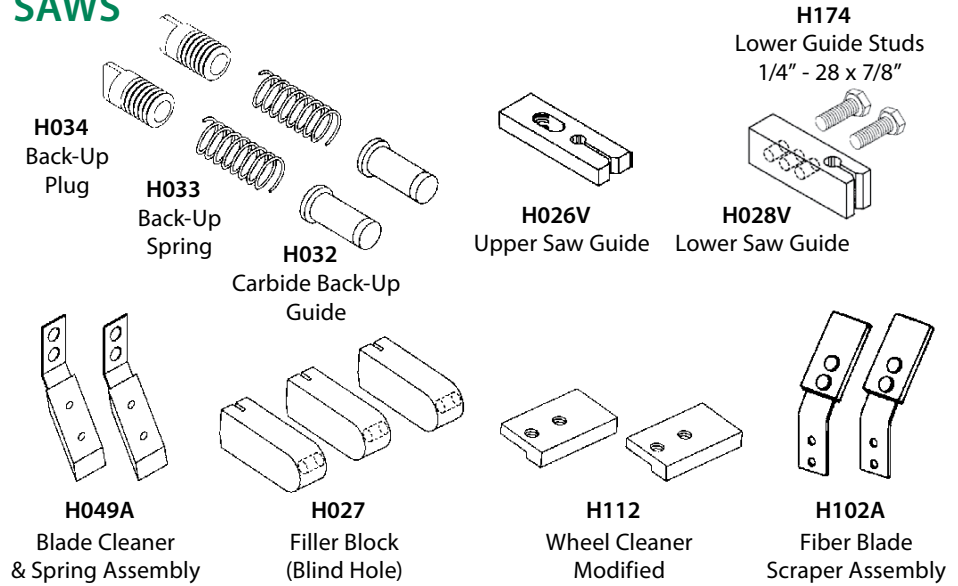

## REPAIR KIT FOR HOBART SAWS



Models 5701, 5801, 6614, 6801

**HRK6**..... Hobart Repair Kit  
Kit Includes:

- 1 ..... Blade Scraper Assy. w/Fiber Scrapers
- 3 ..... Filler Block
- 2 ..... Wheel Cleaner
- 1 ..... Upper Saw Guide & Carbide Plug
- 1 ..... Lower Saw Guide & Carbide Plug
- 2 ..... Fiber Blade Scraper Assembly
- 2 ..... Lower Guide Studs

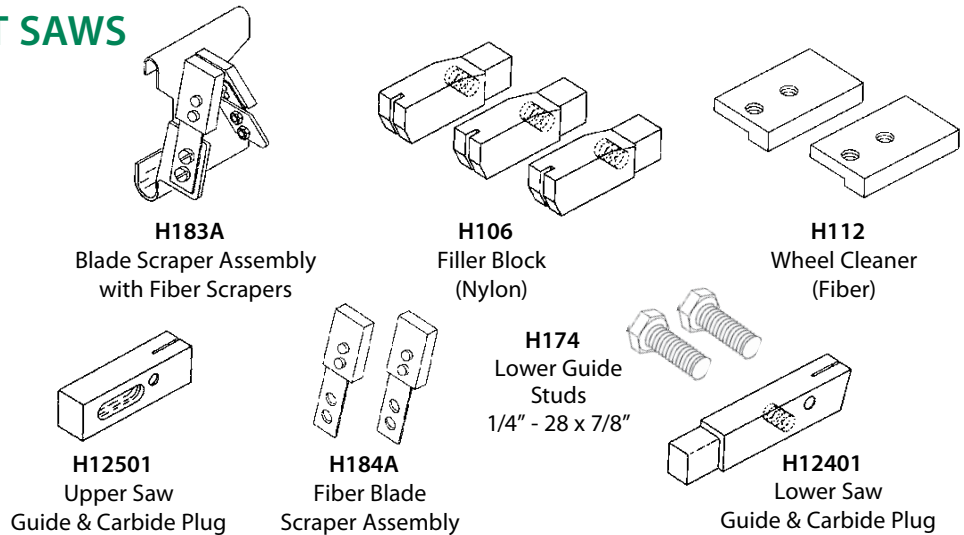

## REPLACEMENT PARTS FOR HOBART SAWS

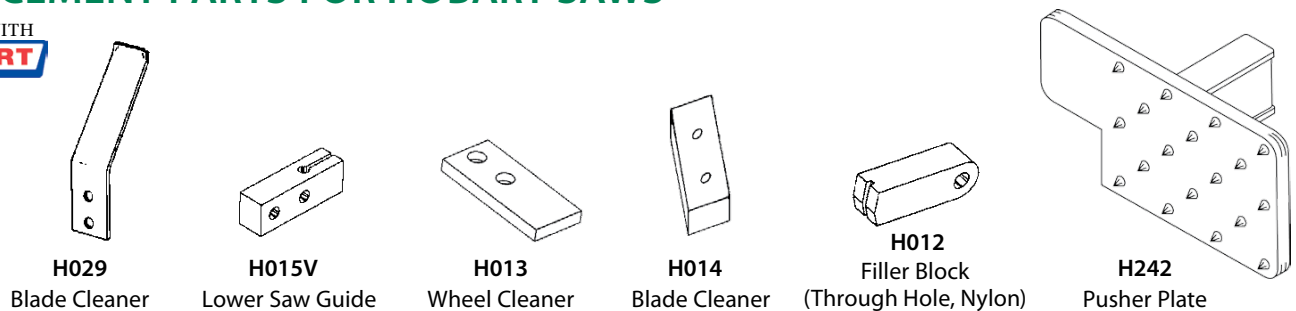

Item Number Description

- H029** ..... Blade Cleaner
- H015V** ..... Lower Saw Guide
- H013** ..... Wheel Cleaner
- H014** ..... Blade Cleaner
- H012** ..... Filler Block (Nylon)
- H242** ..... Pusher Plate

FITS MODELS															
	5012	5014	5016	5114	5116	5212	5214	5216	5514	5614	5700	5701	5801	6614	6801

<b>H029</b>	-	-	-	-	-	X	X	X	X	X	-	-	-	-	-
<b>H015V</b>	-	-	-	X	X	-	X	-	-	-	-	-	-	-	-
<b>H013</b>	-	-	-	-	-	X	X	-	-	-	-	-	-	-	-
<b>H014</b>	X	-	-	-	-	-	X	X	X	X	-	-	-	-	-
<b>H012</b>	X	-	-	X	X	-	X	-	-	-	-	-	-	-	-
<b>H242</b>	-	-	-	-	-	-	-	-	-	-	X	X	X	X	X

