

**BANDSAWS**  
*BIRO*



### FIXED HEAD SAW

- Heavy duty stainless steel base, legs, fixed head and door structures
- Standard motor: 3 HP, 3 phase\* totally enclosed, cord included
- Switch: Watertight magnetic starter with thermal overload and under voltage protection
- Cutting clearance: 15 1/4" x 13 1/8"
- Blade length: 124"
- USDA approved

33345S34003FH ... 16" Meat Saw



### STANDARD SAW

- Features all stainless steel unitized welded base structure - aluminum head structure
- Standard motor: 2 HP, 3 phase\* totally enclosed, cord included
- Switch: Watertight magnetic starter with thermal overload protection
- Cutting clearance: 15 1/2" x 13 1/2"
- Blade length: 124"
- USDA approved

33345S3 ..... 16" Meat Saw



\* Optional motor HP and voltages available. Please call for details

\$ Quantity discount for any one size

## BANDSAW BLADES

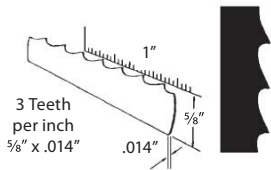

### 314H FROZEN (LT. BLUE WRAPPER)

- 314H112 ..... 112" Blade \$
- 314H124 ..... 124" Blade \$
- 314H126 ..... 126" Blade \$

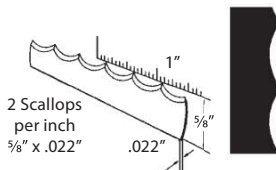

### SE BONELESS (WHITE WRAPPER)

- SE112 ..... 112" Blade \$
- SE124 ..... 124" Blade \$
- SE126 ..... 126" Blade \$
- SE142 ..... 142" Blade \$

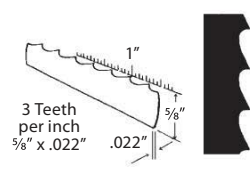

### 322H BONE-IN (ORANGE WRAPPER)

- 322H98 ..... 98" Blade \$
- 322H108 ..... 108" Blade \$
- 322H112 ..... 112" Blade \$
- 322H116 ..... 116" Blade \$
- 322H124 ..... 124" Blade \$
- 322H126 ..... 126" Blade \$
- 322H128 ..... 128" Blade \$
- 322H135 ..... 135" Blade \$
- 322H142 ..... 142" Blade \$
- 322H154 ..... 154" Blade \$

### EXTRA BLADES



- EX251 ..... 25" x 1/2" Blades - Individual
- EX191 ..... 19" x 1/2" Blades - Individual
- EXH ..... Replacement Handle Only Black Plastic (Bolts Included)

### HAND SAWS

- Sanitary black plastic handle and chrome steel frame
- One blade included with all saws



- CH25 ..... Market Size Hand Saw with 25" Blade
- CH19 ..... Hand Saw with 19" Blade

# BANDSAW PARTS

Please call for parts needed that are not illustrated. Most parts readily available including: wheel, shaft and bearing assemblies, cleaner assemblies etc. as well as individual component parts.

## REPLACEMENT PARTS FOR BIRO SAWS

FOR USE WITH  
**BIRO**  
SAWS

### MAINTENANCE/REPAIR KIT

Models 11, 22, 33, 1433, 1433FH, 3334, 3334FH

**BRK2** ..... Biro Repair Kit

Kit Includes:

- |                                     |                                |
|-------------------------------------|--------------------------------|
| 1 ..... Upper Guide & Carbide Block | 2 ..... Wheel Cleaners         |
| 1 ..... Lower Saw Guide             | 2 ..... Bumpers                |
| 3 ..... Filler Blocks               | 2 ..... Blade Cleaner (Steel)  |
| 2 ..... Filler & Guide Studs        | 2 ..... Blade Cleaner (Nyleen) |



**B045602**  
Upper Guide & Carbide Block



**B002119V**  
Lower Saw Guide

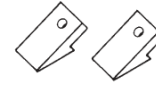

**B005179**  
Wheel Cleaner (Fiber)

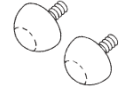

**B008311**  
Bumper

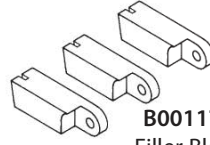

**B001177**  
Filler Block (Nylon)

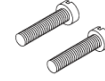

**B017268**  
Filler & Guide Stud

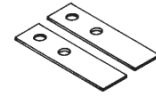

**B004131S**  
Blade Cleaner (Steel)

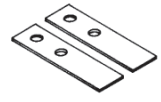

**B004131N**  
Blade Cleaner (Nyleen)

### REPAIR KIT FOR BIRO SAWS

All Models

**BRKFW** ..... Biro Repair Kit

Kit Includes:

- |                        |                                |
|------------------------|--------------------------------|
| 3 ..... Filler Block   | 2 ... Blade Cleaners (Nyleen)  |
| 4 ..... Wheel Cleaners | 2 ..... Blade Cleaners (Steel) |



**B004131S**  
Blade Cleaner (Steel)

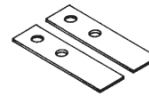

**B004131N**  
Blade Cleaner (Nyleen)

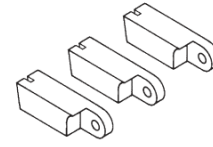

**B001177**  
Filler Block (Nylon)

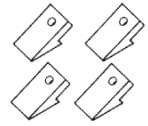

**B005179**  
Wheel Cleaner (Fiber)

Order complete Maintenance/Repair kit or individual parts as needed.

## BIRO SAW PARTS

FOR USE WITH  
**BIRO**  
SAWS



**B045602**  
Upper Guide & Carbide Block

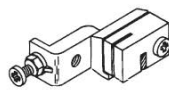

**B055A601**  
Upper Guide & Bracket Assembly



**B020159**  
Table Bearing (1 7/16" dia.)



**B005179**  
Wheel Cleaner



**B141**  
Tension Spring Gauge



**B139**  
Tension Spring Pin

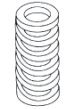

**B140**  
Tension Spring

**B028A415**  
Stationary Bar Assembly



**B032A361/33**  
Lower Wheel Shaft & Bearing Assembly (Straight Shaft only)

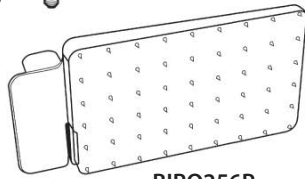

**BIRO256P**  
Pusher Plate

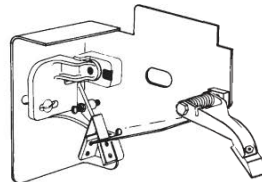

**B018AC**  
Cleaning Unit Assembly Complete with Carbide Block

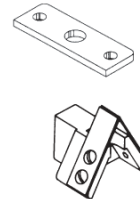

**B024A130/N**  
Blade Scraper Bracket with Cleaners (Nyleen)

**B075**  
Tension Spring Plate

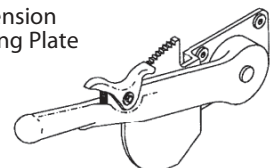

**B136A**  
Ratchet Arm Assembly Complete



**B033A247**  
Upper Wheel Shaft & Bearing Assembly



**B009A295**  
Cleaning Arm Assembly

Item Number	Description	11	22	33	34	44	55	1433	1433FH	3334	3334FH	4436
<b>B045602</b> .....	Upper Guide & Carbide Block	X	X	X	X	X	X	X	-	X	-	X
<b>B055A601</b> .....	Upper Guide & Bracket Assy	X	X	X	X	X	X	X	-	X	-	X
<b>B005179</b> .....	Wheel Cleaner	X	X	X	X	X	X	X	X	X	X	X
<b>B141</b> .....	Tension Spring Gauge	X	X	X	X	-	-	X	-	X	-	-
<b>B140</b> .....	Tension Spring	X	X	X	X	-	-	X	-	X	-	-
<b>B139</b> .....	Tension Spring Pin	X	X	X	X	-	-	X	-	X	-	-
<b>B075</b> .....	Tension Spring Plate	-	-	-	-	-	-	X	-	X	-	-
<b>B028A415</b> .....	Stationary Bar Assy	X	X	X	X	X	-	-	-	X	X	X
<b>B020159</b> .....	Table Bearing	-	-	-	X	X	X	X	X	X	-	-
<b>B024A130/N</b> ...	Blade Scraper Bracket	X	X	X	X	X	-	-	-	X	X	X
<b>B136A</b> .....	Ratchet Arm Assy	X	X	X	X	-	-	X	-	X	-	-
<b>B033A247</b> .....	Upper Wheel Shaft & Bearing Assy	X	X	X	X	-	-	X	X	X	X	-
<b>B032A361/33</b> ..	Lower Wheel Shaft & Bearing Assy	-	-	X	-	-	-	-	-	X	X	-
<b>BIRO256P</b> .....	Pusher Plate	X	X	X	X	X	X	X	X	X	X	X
<b>B018AC</b> .....	Cleaning Unit Assembly	-	-	-	-	-	-	-	-	X	X	-
<b>B009A295</b> .....	Cleaning Arm Assembly	X	X	X	X	X	-	X	X	X	X	X

#### FITS MODELS

11 22 33 34 44 55 1433 1433FH 3334 3334FH 4436

Please call for parts needed that are not illustrated. Most parts readily available including: wheel, shaft and bearing assemblies, cleaner assemblies etc. as well as individual component parts.

## REPLACEMENT PARTS FOR BUTCHER BOY SAWS

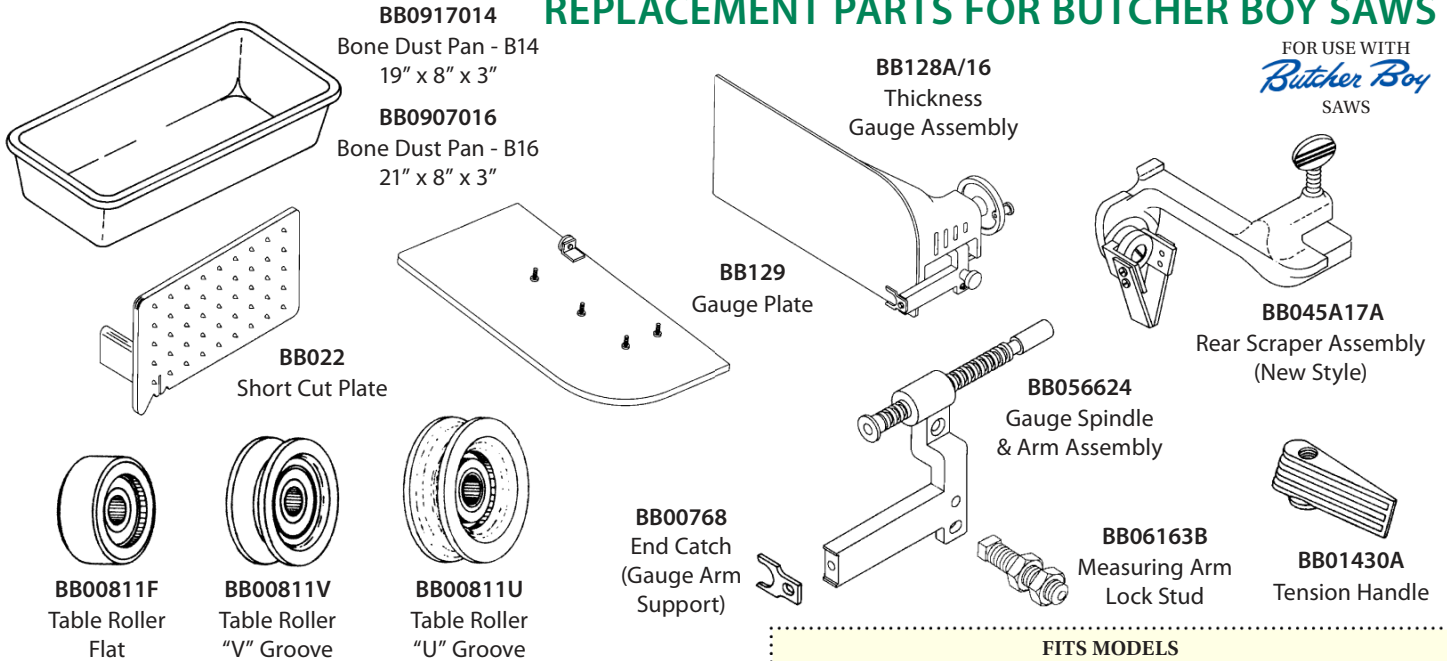

Item Number	Description
<b>BB01430A</b>	Tension Handle
<b>BB0907016</b>	Bone Dust Pan - B16, 21" x 8¼" x 3½"
<b>BB0917014</b>	Bone Dust Pan - B14, 19" x 8½" x 3½"
<b>BB045A17A</b>	Rear Scraper Assembly (New Style)
<b>BB022</b>	Short Cut Plate
<b>BB128A/16</b>	Thickness Gauge Assembly
<b>BB129</b>	Gauge Plate
<b>BB00811F</b>	Table Roller Flat
<b>BB00811V</b>	Table Roller "V" Groove
<b>BB00811U</b>	Table Roller "U" Groove
<b>BB056624</b>	Gauge Spindle & Arm Assembly
<b>BB00768</b>	End Catch (Gauge Arm Support)
<b>BB06163B</b>	Measuring Arm Lock Stud

FITS MODELS									
B12	B14	B16	1435	1640	COBRA		SA16	SA20	
					14	16			
X	X	OLD	X	-	X	-	-	-	
-	-	X	-	X	-	X	-	-	
-	X	-	X	-	X	-	-	-	
X	X	X	X	X	X	X	-	-	
X	X	X	X	X	X	X	-	-	
X	X	X	X	X	X	X	-	-	X
X	X	X	X	X	X	X	-	-	X
X	X	X	X	X	X	X	-	-	X
X	X	X	X	X	X	X	-	-	X

## BUTCHER BOY REPAIR KIT

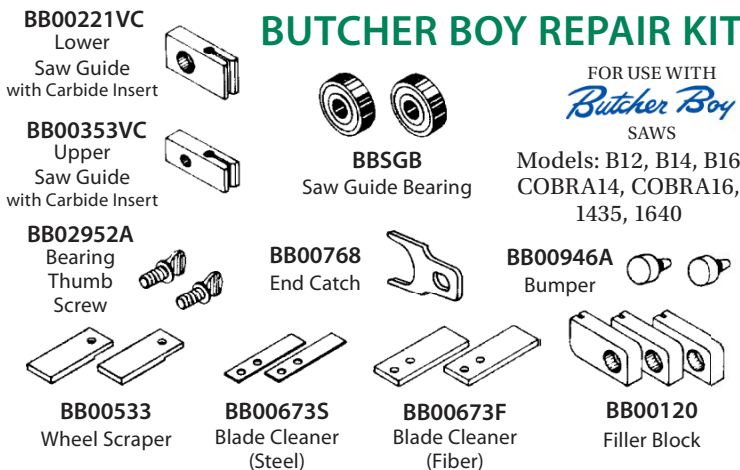

## HARDWARE KIT



**BBRK1** ..... Butcher Boy Repair Kit

Kit Includes:

- |                             |                               |
|-----------------------------|-------------------------------|
| 2 ..... Saw Guide Bearing   | 1 ..... End Catch             |
| 1 ..... Lower Saw Guide     | 2 ..... Blade Cleaner (Steel) |
| 1 ..... Upper Saw Guide     | 2 ..... Bumper                |
| 2 ..... Bearing Thumb Screw | 2 ..... Wheel Scraper         |
| 3 ..... Filler Block        | 2 ..... Blade Cleaner (Fiber) |

We Gladly Welcome



# BANDSAW PARTS

## REPLACEMENT PARTS FOR BUTCHER BOY SAWS

FOR USE WITH  
*Butcher Boy*  
SAWS

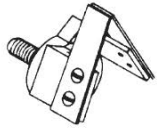

**BB041A66F**  
Blade Scraper Holder  
Assembly (Fiber)

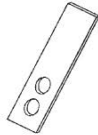

**BB00673F**  
Blade Cleaner (Fiber)

**BB00673S**  
Blade Cleaner (Steel)



**BB00120**  
Filler Block (Nylon)

**BB118**  
Filler Block (Fiber)

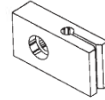

**BB00221V**  
Lower Saw Guide  
with "V" Front

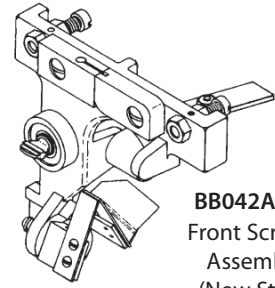

**BB042A15A**  
Front Scraper  
Assembly  
(New Style)



**BB001A20A/S**  
Filler Stud  
(Short) 1"



**BB001A20A/L**  
Scraper Mount Stud  
(Long) 1"



**BB02556C**  
Table Thumb Screw



**BB00946A**  
Bumper

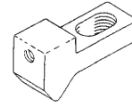

**BB07256F**  
Lever Adjusting Lock

**BB012456**  
Table Stop  
Assembly

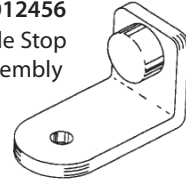

### UPPER WHEEL

Upper wheel assembly with hangers are complete with shaft, bearings, seals, gaskets, spacer, hub cap & retainer.

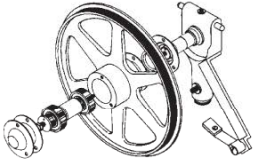

**BB103AH16**  
Wheel Assembly  
with Hanger (New Style)



**BB019A7**  
Upper Shaft & Bearing Assembly  
with Metal Shields



**BBUMB**  
Upper Main Bearing  
with 1 Metal Shield  
(Upper wheel requires 2 bearings)



**BB05241D**  
Upper & Lower  
Shaft Seal



**BB05141C**  
Shaft Gasket

### LOWER WHEEL

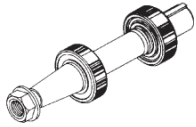

**BB020A23**  
Lower Shaft Assembly  
with Metal Shields



**BBLMB**  
Lower Main Bearing  
with 1 Metal Shield  
(Lower wheel requires 2 bearings)

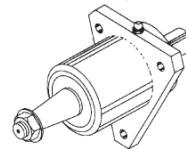

**BB123A**  
Lower Main Bearing Housing Assembly  
Includes bearings, shaft, grease, retaining  
rings, seal, nut, washer & square key



**BB0811610**  
Lower Wheel Only

Item Number

Description

<b>BB00120</b> .....	Filler Block (Nylon)
<b>BB118</b> .....	Filler Block (Fiber)
<b>BB00221V</b> .....	Lower Saw Guide with "V" Front
<b>BB041A66F</b> .....	Blade Scraper Holder Assembly (Fiber)
<b>BB001A20A/S</b> .....	Filler Stud (Short) 3/4"
<b>BB001A20A/L</b> .....	Scraper Mount Stud (Long) 1"
<b>BB00673F</b> .....	Blade Cleaner (Fiber)
<b>BB00673S</b> .....	Blade Cleaner (Steel)
<b>BB042A15A</b> .....	Front Scraper Assembly (New Style)
<b>BB00946A</b> .....	Bumper
<b>BB07256F</b> .....	Lever Adjusting Lock
<b>BB02556C</b> .....	Table Thumb Screw
<b>BB012456</b> .....	Table Stop Assembly
<b>BB103AH16</b> .....	Wheel Assembly with Hanger (New Style)
<b>BB019A7</b> .....	Upper Shaft & Bearing Assembly with Metal Shields
<b>BB020A23</b> .....	Lower Shaft & Bearing Assembly with Metal Shields
<b>BB123A</b> .....	Lower Main Bearing Housing Assembly
<b>BB0811610</b> .....	Lower Wheel only
<b>BBUMB</b> .....	Upper Main Bearing with 1 Metal Shield
<b>BB05241D</b> .....	Upper & Lower Shaft Seal
<b>BB05141C</b> .....	Shaft Gasket
<b>BBLMB</b> .....	Lower Main Bearing with 1 Metal Shield

#### FITS MODELS

	B12	B14	B16	1435	1640	COBRA		SA20
						14	16	
	X	X	X	X	X	X	X	-
	X	X	X	X	X	X	X	-
	X	X	X	X	X	X	X	X
	X	X	X	X	X	X	X	-
	X	X	X	X	X	-	-	X
	X	X	X	X	X	-	-	-
	X	X	X	X	X	-	-	-
	X	X	X	X	X	-	-	X
	-	-	X	-	X	-	X	-
	X	X	X	X	X	X	X	X
	X	X	X	X	X	X	X	X
	X	X	X	X	X	X	X	X
	X	X	X	X	X	X	X	X
	X	X	X	X	X	X	X	X



26

Many parts are interchangeable. Please check reference charts to make sure parts are compatible with your model of saw.

## REPLACEMENT PARTS FOR BUTCHER BOY SAWS

FOR USE WITH  
*Butcher Boy*  
SAWS

**BB102A**  
Upper Wheel Hanger -  
New Style (Complete with  
Tension Gauge Indicator,  
Spring & Cleaner Arm  
Assembly)

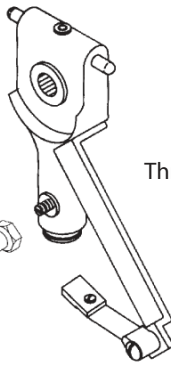

**BB112**  
Threaded Sleeve

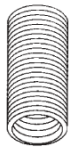

**BB110**  
Tension Gauge  
Indicator



**BB0043F**  
Door Latch (New Style)

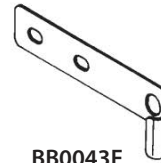

Note:  
"NEW" B16  
- Tension  
Handle  
located below  
Upper Wheel

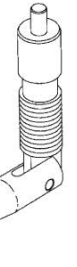

**BB111**  
Wheel Adjusting  
Screw & Nut



**BB00533**  
Wheel Scraper  
(Fiber)



**BB03959**  
Wheel Scraper Spring

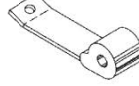

**BB0973D**  
Door Pull Guide Knob



**BB101A**  
Tension Adjusting Screw  
& Handle Assembly  
New Style B16

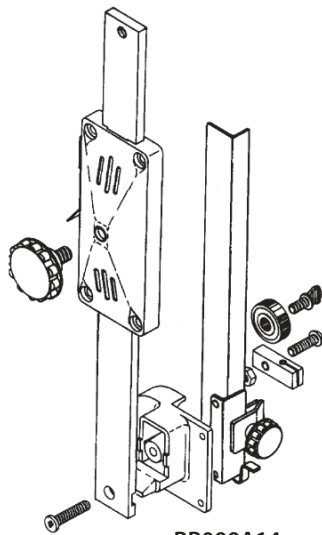

**BB099A14**

Adjusting Bar Guide Assembly Complete  
with Guide & Roller Mount Assembly Bar  
Length: 18½"

**BB133**  
Blade Guard  
Knob



**BB02439**  
Blade Guard



**BB04738A/16**  
Blade Support  
Adjusting Bar  
B16 Length: 18½"



**BB09514A**  
Adjusting Bar Guide  
with Spring Lock

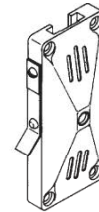

**BB09637A**  
Adjusting Bar  
Guide Knob



**BB04640**  
Adjusting Guide  
& Roller Mount

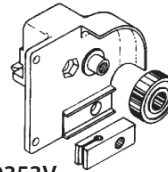

**BBSGB**  
Saw Guide  
Bearing with  
Metal Shields

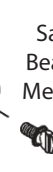

**BB00353V**  
Upper Saw Guide  
with "V" Front

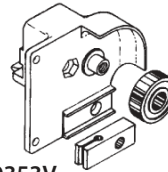

**BB02952A**  
Bearing Thumb  
Screw

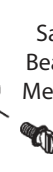

Item Number	Description
BB102A	Upper Wheel Hanger (New Style)
BB111	Wheel Adjusting Screw & Nut
BB112	Threaded Sleeve
BB110	Tension Gauge Indicator
BB0043F	Door Latch (New Style)
BB00533	Wheel Scraper (Fiber)
BB03959	Wheel Scraper Spring
BB0973D	Door Pull Guide Knob
BB101A	Tension Adjusting Screw & Handle Assembly
BB099A14	Adjusting Bar Guide Assembly
BB04738A/16	Blade Support Adjusting Bar
BB133	Blade Guard Knob
BB02439	Blade Guard
BB09514A	Adjusting Bar Guide with Spring Lock
BB09637A	Adjusting Bar Guide Knob
BB04640	Adjusting Guide & Roller Mount
BBSGB	Saw Guide Bearing with Metal Shields
BB00353V	Upper Saw Guide with "V" Front
BB02952A	Bearing Thumb Screw

FITS MODELS							
B12	B14	B16	1435	1640	14	16	SA20

		NEW	-	X	-	X	-
		NEW	-	X	-	X	X
		NEW	-	X	-	X	X
		NEW	-	X	X	X	X
X	X	X	-	-	-	-	-
X	X	NEW	X	X	X	X	X
X	X	NEW	X	X	X	X	-
X	X	X	-	-	-	-	-
-	-	NEW	-	X	-	X	-
X	X	X	-	-	-	X	-
-	-	X	-	-	-	-	-
X	X	X	X	X	X	X	X
X	X	X	-	-	-	-	-
X	X	X	-	-	-	-	X
X	X	X	-	-	-	-	-
X	X	X	-	-	-	-	-
X	X	X	-	-	-	-	-
X	X	X	-	-	-	-	-
X	X	X	-	-	-	-	-
X	X	X	-	-	-	-	-

# BANDSAW PARTS

Please call for parts needed that are not illustrated. Most parts readily available including: wheel, shaft and bearing assemblies, cleaner assemblies etc. as well as individual component parts.

## REPAIR KIT FOR HOBART SAWS



Models 5212, 5214, 5216, 5514

**HRK1**..... Hobart Repair Kit  
Kit Includes:

- 2 ..... Back-Up Plug
- 2 ..... Back-Up Spring
- 2 ..... Carbide Back-Up Guide
- 1 ..... Upper Saw Guide
- 1 ..... Lower Saw Guide
- 2 ..... Lower Guide Studs
- 2 ..... Blade Cleaner & Wheel Assy
- 3 ..... Filler Block (Blind Hole)
- 2 ..... Wheel Cleaner Modified
- 2 ..... Fiber Blade Scraper Assy

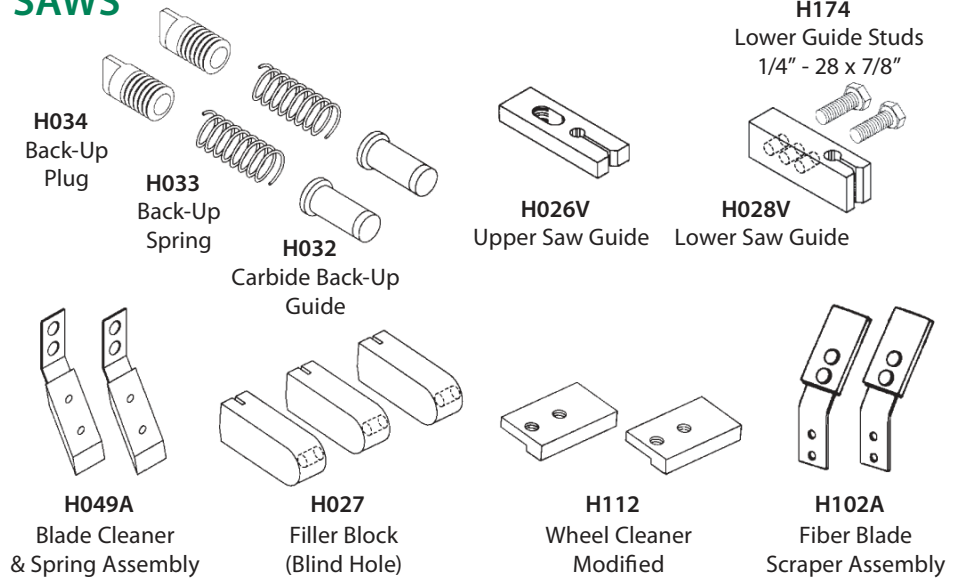

## REPAIR KIT FOR HOBART SAWS



Models 5701, 5801, 6614, 6801

**HRK6**..... Hobart Repair Kit  
Kit Includes:

- 1 ..... Blade Scraper Assy. w/Fiber Scrapers
- 3 ..... Filler Block
- 2 ..... Wheel Cleaner
- 1 ..... Upper Saw Guide & Carbide Plug
- 1 ..... Lower Saw Guide & Carbide Plug
- 2 ..... Fiber Blade Scraper Assembly
- 2 ..... Lower Guide Studs

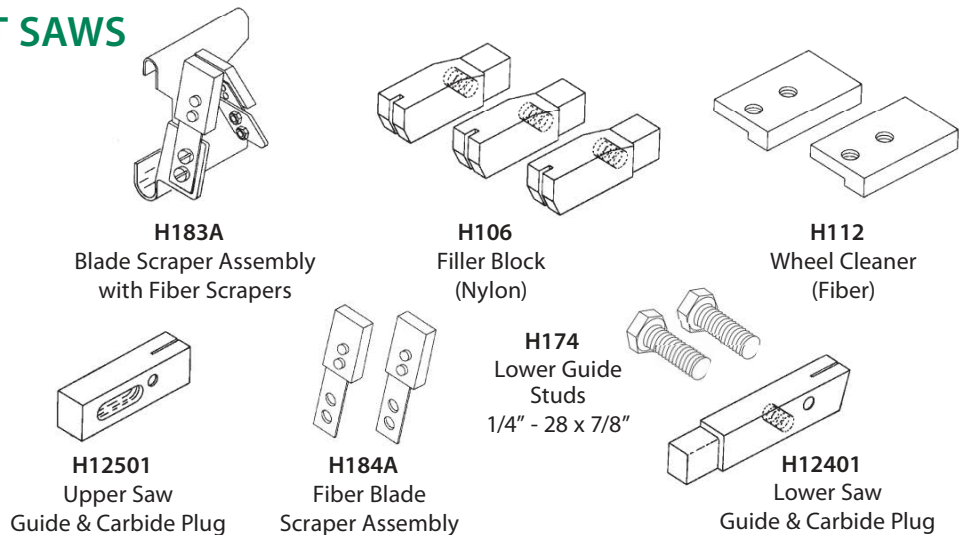

## REPLACEMENT PARTS FOR HOBART SAWS

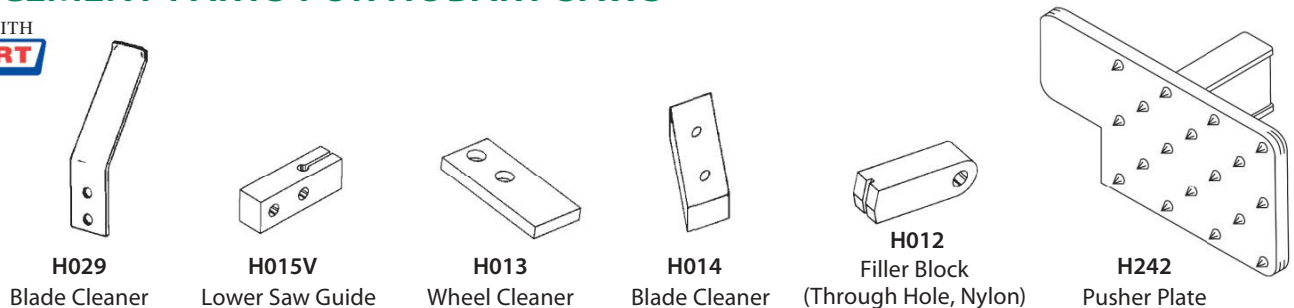

Item Number	Description	FITS MODELS													
		5012	5014	5016	5114	5116	5212	5214	5216	5514	5614	5700	5701	5801	6614

<b>H029</b>	Blade Cleaner	-	-	-	-	-	X	X	X	X	X	-	-	-	-	-
<b>H015V</b>	Lower Saw Guide	-	-	-	X	X	-	X	-	-	-	-	-	-	-	-
<b>H013</b>	Wheel Cleaner	-	-	-	-	-	X	X	-	-	-	-	-	-	-	-
<b>H014</b>	Blade Cleaner	X	-	-	-	-	-	X	X	X	X	-	-	-	-	-
<b>H012</b>	Filler Block (Nylon)	X	-	-	X	X	-	X	-	-	-	-	-	-	-	-
<b>H242</b>	Pusher Plate	-	-	-	-	-	-	-	-	-	-	X	X	X	X	X

