

# TENDERIZER PARTS

Most parts readily available. Please call for parts needed that are not illustrated.

## REPLACEMENT PARTS FOR BERKEL TENDERIZERS

Models 703, 704 & 705

FOR USE WITH



SLICING MACHINES

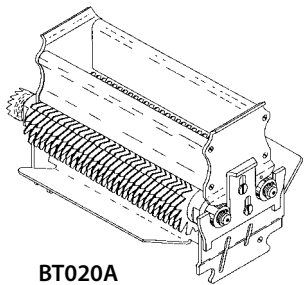

**BT020A**  
Complete Blade Frame  
Assembly (Ready to drop in)

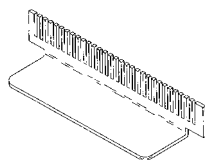

**BT002**  
Blade Stripper  
Front or Rear

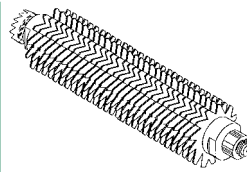

**BT022F**  
Front Blade  
Shaft Assembly  
(Complete)

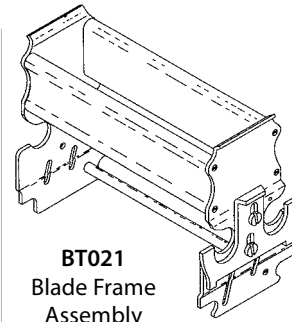

**BT021**  
Blade Frame  
Assembly

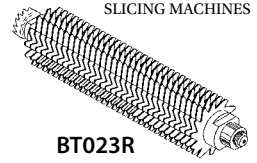

**BT023R**  
Rear Blade  
Shaft Assembly  
(Complete)

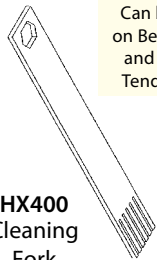

**HX400**  
Cleaning  
Fork

Can be used  
on Berkel, Biro  
and Hobart  
Tenderizers.

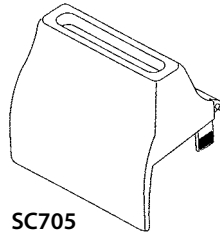

**SC705**  
Safety Cover

Item Number	Description	FITS MODELS		
		703	704	705
<b>BT020A</b>	Complete Blade Frame Assembly	X	X	X
<b>BT002</b>	Blade Stripper, Front or Rear	X	X	X
<b>BT022F</b>	Front Blade Shaft Assembly (Complete)	X	X	X
<b>BT021</b>	Blade Frame Assembly	X	X	X
<b>BT023R</b>	Rear Blade Shaft Assembly (Complete)	X	X	X
<b>HX400</b>	Cleaning Fork	X	X	X
<b>SC705</b>	Safety Cover	-	-	X

## REPLACEMENT PARTS FOR BIRO TENDERIZERS

Model PRO 9

FOR USE WITH



SAWS

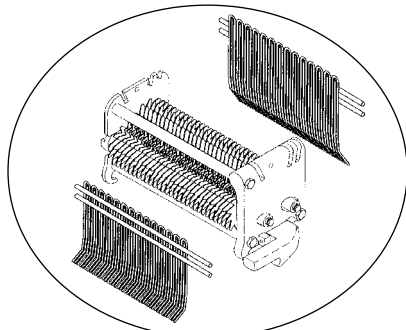

**B320A**  
Cradle Assembly - Complete  
Cradle, Knife Shaft Assemblies,  
Combs and Lock Lever

**B314F**  
Front Knife  
Shaft  
Assembly

**B315B**  
Back Knife  
Shaft  
Assembly

**B302B**  
Back Wire  
Comb

**B301F**  
Front Wire  
Comb

**BT961**  
Transparent  
Plastic Cover

## REPLACEMENT PARTS FOR HOBART TENDERIZERS

Models 401 & 403

FOR USE WITH



SAWS

**HT102B**  
Back  
Stripper

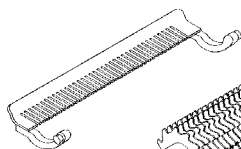

**HT117B**  
Blade Shaft  
Assembly -Back

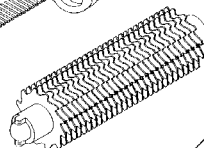

**HT100**  
Hanger  
Sub-Assembly

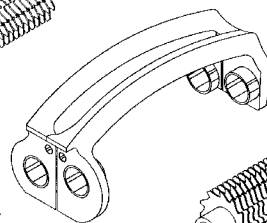

**HT116F**  
Blade Shaft  
Assembly -Front

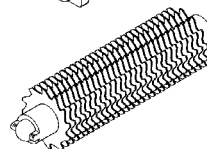

**HT120**  
Safety  
Cover

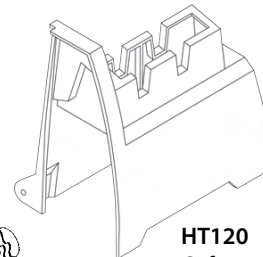

**HT111A**  
Lift Out Unit -  
Complete

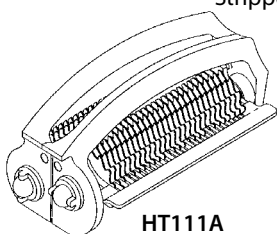

**HT113**  
Hanger Lock (Includes  
Hardware)

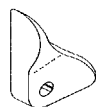

**HT101F**  
Front  
Stripper

