

# TENDERIZER PARTS

Most parts readily available. Please call for parts needed that are not illustrated.

## REPLACEMENT PARTS FOR BERKEL TENDERIZERS

Models 703, 704 & 705

FOR USE WITH  
**Berkel**  
SLICING MACHINES

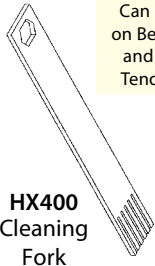
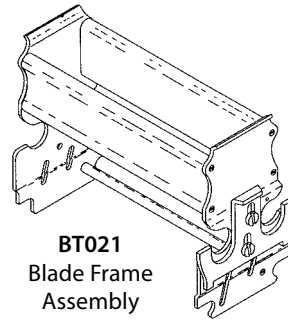
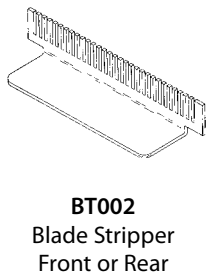
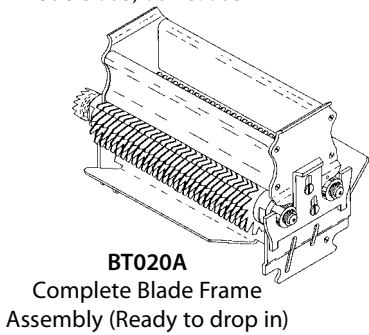

Can be used on Berkel, Biro and Hobart Tenderizers.



Item Number	Description	FITS MODELS		
		703	704	705
<b>BT020A</b>	Complete Blade Frame Assembly	X	X	X
<b>BT002</b>	Blade Stripper, Front or Rear	X	X	X
<b>BT022F</b>	Front Blade Shaft Assembly (Complete)	X	X	X
<b>BT021</b>	Blade Frame Assembly	X	X	X
<b>BT023R</b>	Rear Blade Shaft Assembly (Complete)	X	X	X
<b>HX400</b>	Cleaning Fork	X	X	X
<b>SC705</b>	Safety Cover	-	-	X

## REPLACEMENT PARTS FOR BIRO TENDERIZERS

Model PRO 9

FOR USE WITH  
**BIRO**  
SAWS

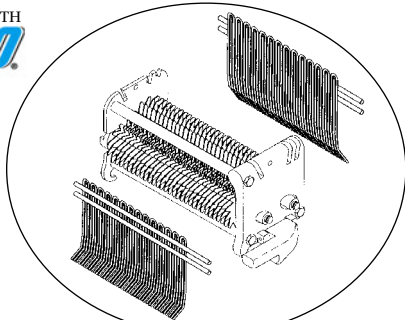

**B314F**  
Front Knife Shaft Assembly

**B315B**  
Back Knife Shaft Assembly

**B302B**  
Back Wire Comb

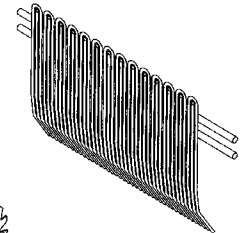

**B301F**  
Front Wire Comb

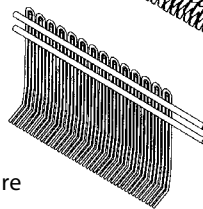

**BT961**  
Transparent Plastic Cover

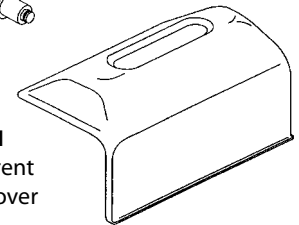

## REPLACEMENT PARTS FOR HOBART TENDERIZERS

Models 401 & 403

FOR USE WITH  
**HOBART**  
SAWS

**HT102B**  
Back Stripper

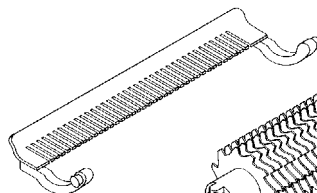

**HT117B**  
Blade Shaft Assembly - Back

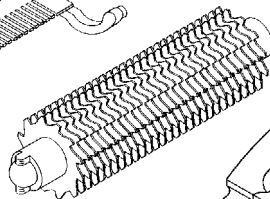

**HT100**  
Hanger Sub-Assembly

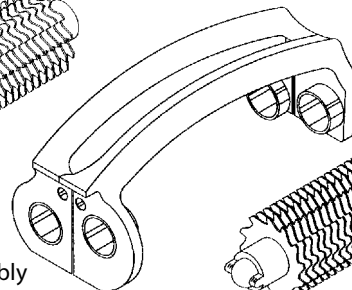

**HT113**  
Hanger Lock (Includes Hardware)

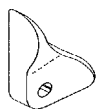

**HT116F**  
Blade Shaft Assembly - Front

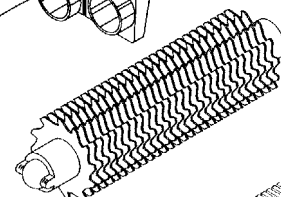

**HT101F**  
Front Stripper

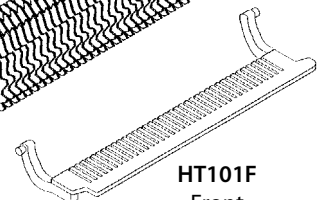

**HT111A**  
Lift Out Unit - Complete

